

# STAMFORD®

## PI144G - Winding 311 Technical Data Sheet

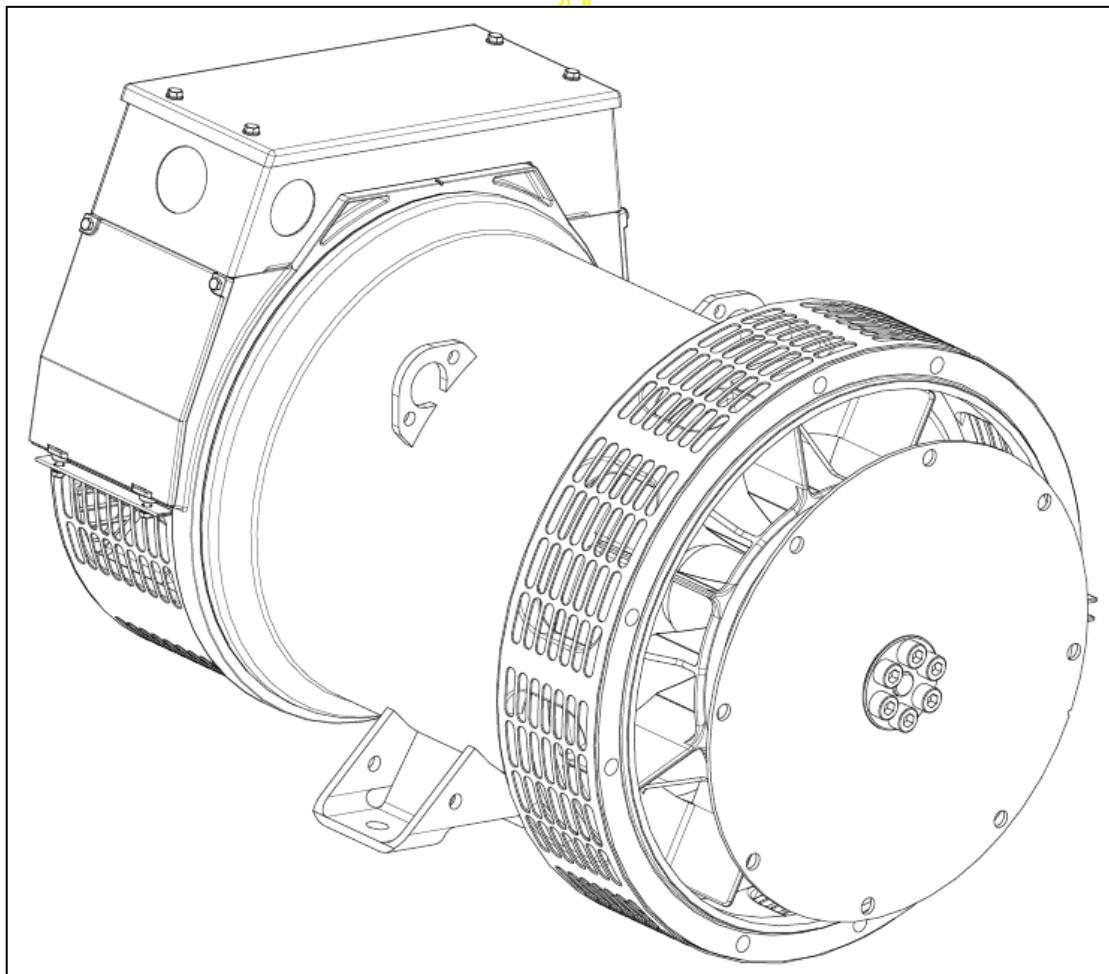

**PI144G  
SPECIFICATIONS & OPTIONS**

**STANDARDS**

Stamford industrial generators meet the requirements of BS EN 60034 and the relevant section of other international standards such as BS5000, VDE 0530, NEMA MG1-32, IEC34, CSA C22.2-100, AS1359. Other standards and certifications can be considered on request.

**VOLTAGE REGULATOR**

**AS480 AVR fitted as STANDARD**

With this self-excited system the main stator provides power via the AVR to the exciter stator. The high efficiency semi-conductors of the AVR ensure positive build-up from initial low levels of residual voltage.

The exciter rotor output is fed to the main rotor through a three-phase full-wave bridge rectifier. The rectifier is protected by a surge suppressor against surges caused, for example, by short circuit or out-of-phase paralleling. The AS480 will support limited accessories, RFI suppression remote voltage trimmer and for the P1 range only a 'droop' Current Transformer (CT) to permit parallel operation with other ac generators.

The AVR is can be fitted to either side of the generator in its own housing in the non-drive end bracket.

**Excitation Boost System (EBS) (OPTIONAL)**

The EBS is a single, self-contained unit, attached to the non-drive end of the generator.

The EBS unit consists of the Excitation Boost Controller (EBC) and an Excitation Boost Generator (EBG). Under fault conditions, or when the generator is subjected to a large impact load such as a motor starting, the generator voltage will drop. The EBC senses the drop in voltage and engages the output power of the EBG. This additional power feeds the generator's excitation system, supporting the load until breaker discrimination can remove the fault or enable the generator to pick up a motor and drive the voltage recovery.

**WINDINGS & ELECTRICAL PERFORMANCE**

All generator stators are wound to 2/3 pitch. This eliminates triplen (3rd, 9th, 15th ...) harmonics on the voltage waveform and is found to be the optimum design for trouble-free supply of non-linear loads. The 2/3 pitch design avoids excessive neutral currents sometimes seen with higher winding pitches, when in parallel with the mains. A fully connected damper winding reduces oscillations during paralleling. This winding, with the 2/3 pitch and carefully selected pole and tooth designs, ensures very low waveform distortion.

**TERMINALS & TERMINAL BOX**

Standard generators are 3-phase reconnectable with 12 ends brought out to the terminals, which are mounted at the non-drive end of the generator. Dedicated single phase generators are also available. A sheet steel terminal box contains provides ample space for the customers' wiring and gland arrangements. Alternative terminal boxes are available for customers who want to fit additional components in the terminal box.

**SHAFT & KEYS**

All generator rotors are dynamically balanced to better than BS6861:Part 1 Grade 2.5 for minimum vibration in operation. Two bearing generators are balanced with a half key.

**INSULATION / IMPREGNATION**

The insulation system is class 'H'.

All wound components are impregnated with materials and processes designed specifically to provide the high build required for static windings and the high mechanical strength required for rotating components.

**QUALITY ASSURANCE**

Generators are manufactured using production procedures having a quality assurance level to BS EN ISO 9001.

The stated voltage regulation may not be maintained in the presence of certain radio transmitted signals. Any change in performance will fall within the limits of Criteria 'B' of EN 61000-6-2:2001. At no time will the steady-state voltage regulation exceed 2%.

**DE RATES**

All values tabulated on page 9 are subject to the following reductions

- 5% when air inlet filters are fitted.
- 3% for every 500 metres by which the operating altitude exceeds 1000 metres above mean sea level.
- 3% for every 5°C by which the operational ambient temperature exceeds 40°C.
- Note: Requirement for operating in an ambient exceeding 60°C must be referred to the factory.

5% For reverse rotation  
(Standard rotation CW when viewed from DE)

*NB Continuous development of our products entitles us to change specification details without notice, therefore they must not be regarded as binding.*

*Front cover drawing typical of product range.*

APPROVED DOCUMENT

# PI144G

## WINDING 311

**STAMFORD**

|   |  |                         |         |                                   |                         |         |         |         |
|---|--|-------------------------|---------|-----------------------------------|-------------------------|---------|---------|---------|
| CONTROL SYSTEM  | STANDARD AS480 AVR (SELF EXCITED)  |                         |         |                                   |                         |         |         |         |
| VOLTAGE REGULATION  | ± 1.0 %  |                         |         |                                   |                         |         |         |         |
| SUSTAINED SHORT CIRCUIT   | SELF EXCITED MACHINES DO NOT SUSTAIN A SHORT CIRCUIT CURRENT                         |                         |         |                                   |                         |         |         |         |
| CONTROL SYSTEM  | AS480 AVR WITH OPTIONAL EXCITATION BOOST SYSTEM (EBS)                                |                         |         |                                   |                         |         |         |         |
| SUSTAINED SHORT CIRCUIT   | REFER TO SHORT CIRCUIT DECREMENT CURVE (page 8)                                      |                         |         |                                   |                         |         |         |         |
| STATOR WINDING  | DOUBLE LAYER CONCENTRIC  |                         |         |                                   |                         |         |         |         |
| WINDING PITCH   | TWO THIRDS   |                         |         |                                   |                         |         |         |         |
| WINDING LEADS   | 12   |                         |         |                                   |                         |         |         |         |
| STATOR WDG. RESISTANCE  | 0.222 Ohms PER PHASE AT 22°C SERIES STAR CONNECTED                                   |                         |         |                                   |                         |         |         |         |
| ROTOR WDG. RESISTANCE   | 0.857 Ohms at 22°C   |                         |         |                                   |                         |         |         |         |
| EXCITER STATOR RESISTANCE   | 20.3 Ohms at 22°C  |                         |         |                                   |                         |         |         |         |
| EXCITER ROTOR RESISTANCE  | 0.201 Ohms PER PHASE AT 22°C   |                         |         |                                   |                         |         |         |         |
| EBS STATOR RESISTANCE   | 12.9 Ohms at 22°C  |                         |         |                                   |                         |         |         |         |
| R.F.I. SUPPRESSION  | BS EN 61000-6-2 & BS EN 61000-6-4, VDE 0875G, VDE 0875N. refer to factory for others |                         |         |                                   |                         |         |         |         |
| WAVEFORM DISTORTION   | NO LOAD < 1.5% NON-DISTORTING BALANCED LINEAR LOAD < 5.0%                            |                         |         |                                   |                         |         |         |         |
| MAXIMUM OVERSPEED   | 2250 Rev/Min   |                         |         |                                   |                         |         |         |         |
| BEARING DRIVE END   | BALL. 6309 - 2RS. (ISO)  |                         |         |                                   |                         |         |         |         |
| BEARING NON-DRIVE END   | BALL. 6306 - 2RS. (ISO)  |                         |         |                                   |                         |         |         |         |
|   | 1 BEARING  |                         |         | 2 BEARING                         |                         |         |         |         |
|   | WITH EBS   | WITHOUT EBS             |         | WITH EBS                          | WITHOUT EBS             |         |         |         |
| WEIGHT COMP. GENERATOR  | 160 kg   | 158.3 kg                |         | 163 kg                            | 161.3 kg                |         |         |         |
| WEIGHT WOUND STATOR   | 68 kg  | 68 kg                   |         | 68 kg                             | 68 kg                   |         |         |         |
| WEIGHT WOUND ROTOR  | 57.39 kg   | 55.68 kg                |         | 58.39 kg                          | 56.69 kg                |         |         |         |
| WR <sup>2</sup> INERTIA   | 0.2196 kgm <sup>2</sup>  | 0.2179 kgm <sup>2</sup> |         | 0.2198 kgm <sup>2</sup>           | 0.2181 kgm <sup>2</sup> |         |         |         |
| SHIPPING WEIGHTS in a crate   | 178 kg   | 176.3 kg                |         | 187 kg                            | 185.3 kg                |         |         |         |
| PACKING CRATE SIZE  | 85 x 51 x 67 (cm)  |                         |         | 85 x 51 x 67 (cm)                 |                         |         |         |         |
|   | 50 Hz  |                         |         | 60 Hz                             |                         |         |         |         |
| TELEPHONE INTERFERENCE  | THF < 2%   |                         |         | TIF < 50                          |                         |         |         |         |
| COOLING AIR   | 0.100 m <sup>3</sup> /sec 212cfm   |                         |         | 0.122 m <sup>3</sup> /sec 251 cfm |                         |         |         |         |
| VOLTAGE SERIES STAR   | 380/220  | 400/231                 | 415/240 | 440/254                           | 416/240                 | 440/254 | 460/266 | 480/277 |
| VOLTAGE PARALLEL STAR   | 190/110  | 200/115                 | 208/120 | 220/127                           | 208/120                 | 220/127 | 230/133 | 240/138 |
| VOLTAGE SERIES DELTA  | 220/110  | 230/115                 | 240/120 | 254/127                           | 240/120                 | 254/127 | 266/133 | 277/138 |
| kVA BASE RATING FOR REACTANCE VALUES  | 30   | 30                      | 30      | 28.5                              | 33                      | 35.3    | 36.4    | 37.5    |
| X <sub>d</sub> DIR. AXIS SYNCHRONOUS  | 1.74   | 1.57                    | 1.46    | 1.23                              | 2.06                    | 1.97    | 1.86    | 1.76    |
| X' <sub>d</sub> DIR. AXIS TRANSIENT   | 0.16   | 0.14                    | 0.13    | 0.11                              | 0.19                    | 0.18    | 0.17    | 0.16    |
| X'' <sub>d</sub> DIR. AXIS SUBTRANSIENT   | 0.12   | 0.11                    | 0.10    | 0.09                              | 0.14                    | 0.13    | 0.13    | 0.12    |
| X <sub>q</sub> QUAD. AXIS REACTANCE   | 0.83   | 0.75                    | 0.70    | 0.59                              | 0.99                    | 0.95    | 0.89    | 0.85    |
| X'' <sub>q</sub> QUAD. AXIS SUBTRANSIENT  | 0.18   | 0.16                    | 0.15    | 0.13                              | 0.21                    | 0.20    | 0.19    | 0.18    |
| X <sub>L</sub> LEAKAGE REACTANCE  | 0.07   | 0.06                    | 0.06    | 0.05                              | 0.08                    | 0.08    | 0.07    | 0.07    |
| X <sub>2</sub> NEGATIVE SEQUENCE  | 0.16   | 0.14                    | 0.13    | 0.11                              | 0.18                    | 0.17    | 0.16    | 0.15    |
| X <sub>0</sub> ZERO SEQUENCE  | 0.07   | 0.06                    | 0.06    | 0.05                              | 0.08                    | 0.08    | 0.07    | 0.07    |
| REACTANCES ARE SATURATED      VALUES ARE PER UNIT AT RATING AND VOLTAGE INDICATED |  |                         |         |                                   |                         |         |         |         |
| T' <sub>d</sub> TRANSIENT TIME CONST.   | 0.024 s  |                         |         |                                   |                         |         |         |         |
| T'' <sub>d</sub> SUB-TRANSTIME CONST.   | 0.006 s  |                         |         |                                   |                         |         |         |         |
| T' <sub>do</sub> O.C. FIELD TIME CONST.   | 0.55 s   |                         |         |                                   |                         |         |         |         |
| T <sub>a</sub> ARMATURE TIME CONST.   | 0.007 s  |                         |         |                                   |                         |         |         |         |
| SHORT CIRCUIT RATIO   | 1/X <sub>d</sub>   |                         |         |                                   |                         |         |         |         |

50  
Hz

PI144G  
Winding 311

**STAMFORD**

**THREE PHASE EFFICIENCY CURVES**

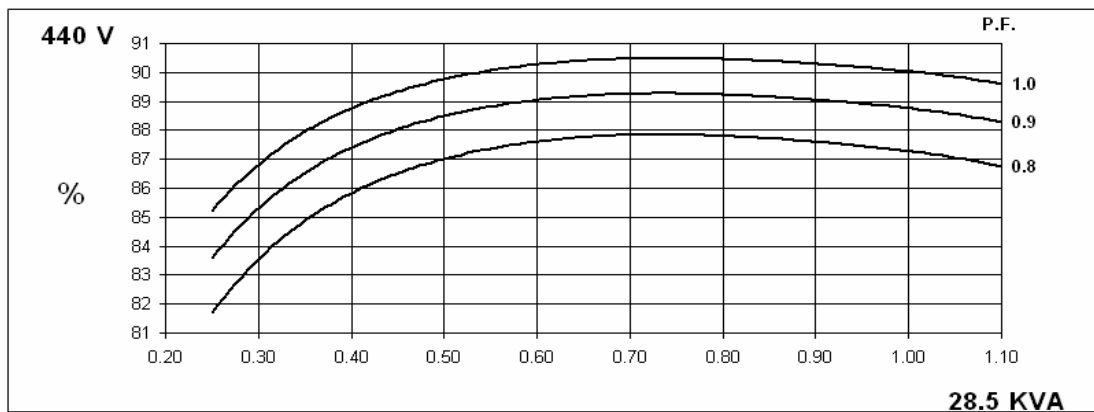
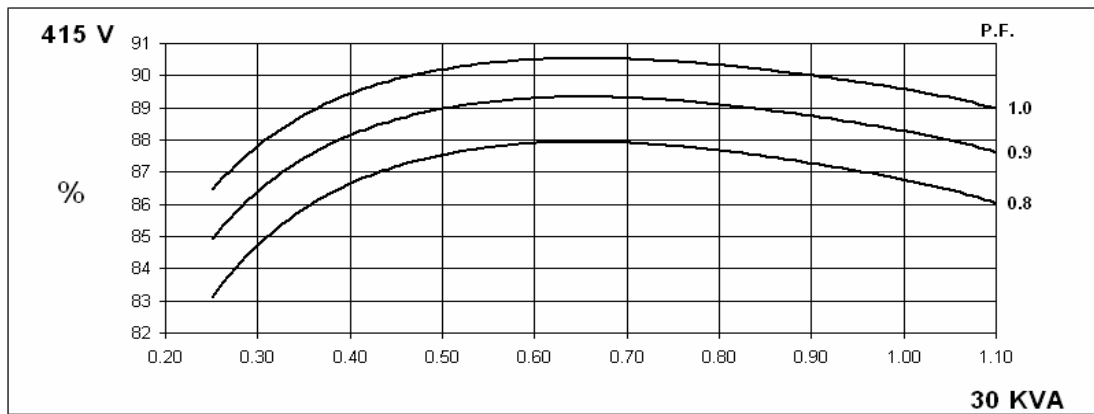
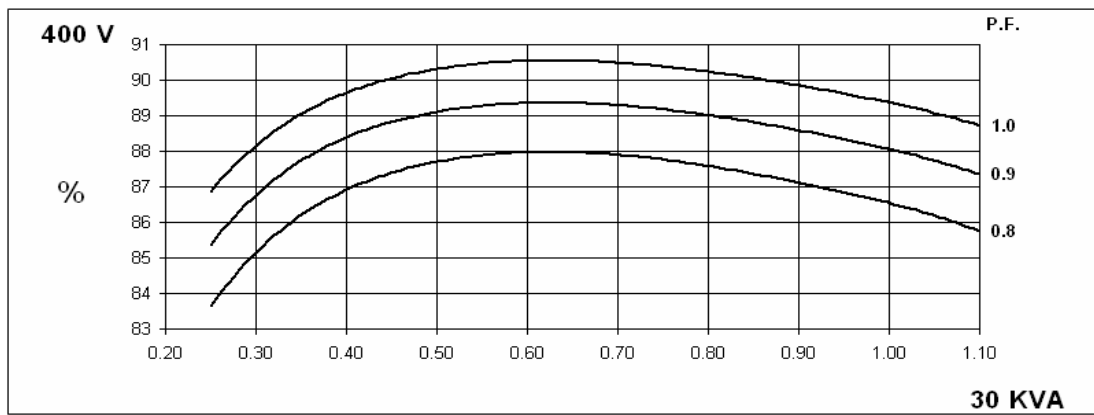
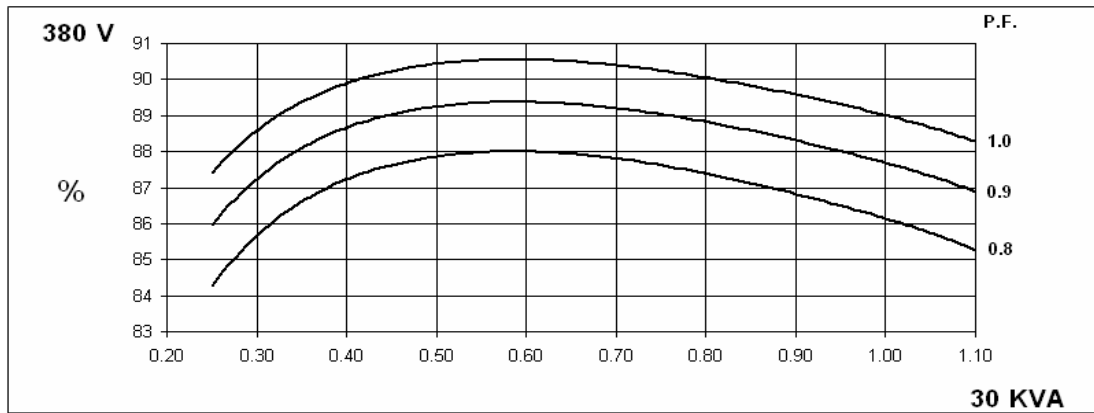

60  
Hz

PI144G  
Winding 311

STAMFORD

THREE PHASE EFFICIENCY CURVES

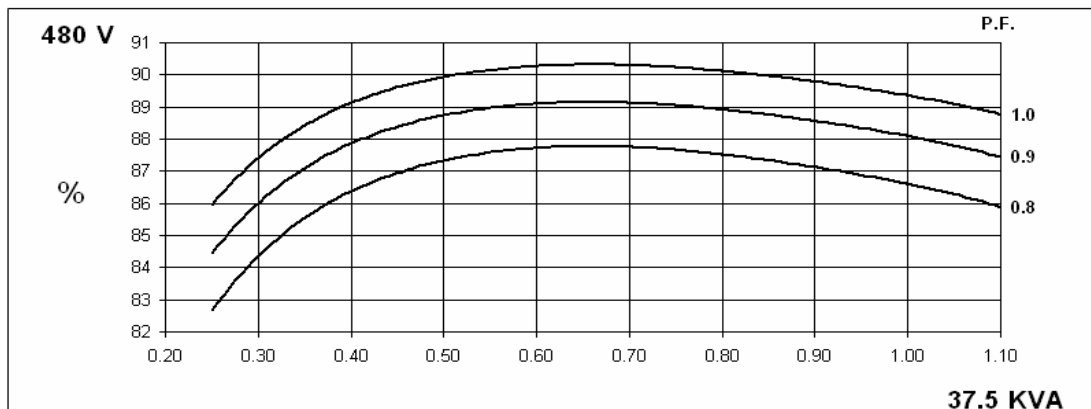
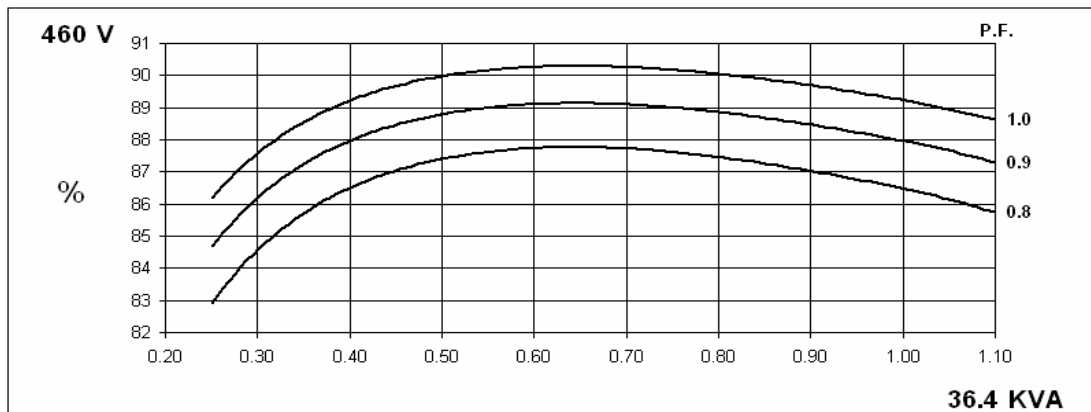
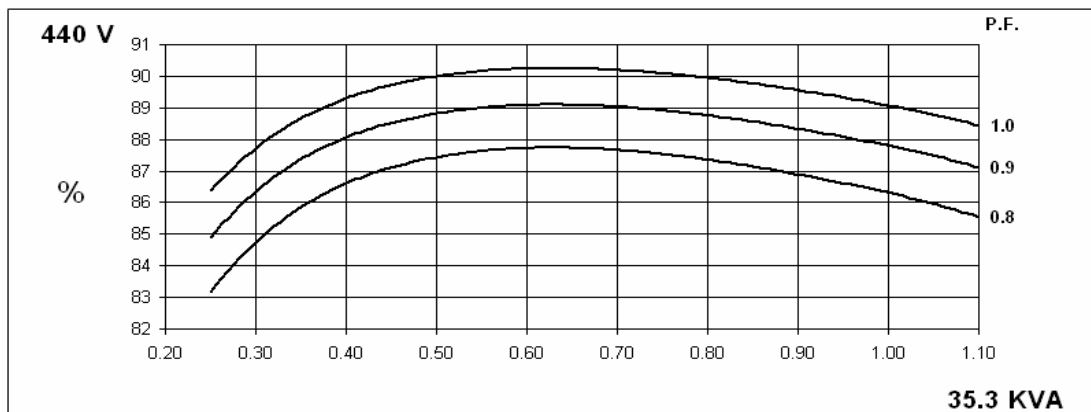
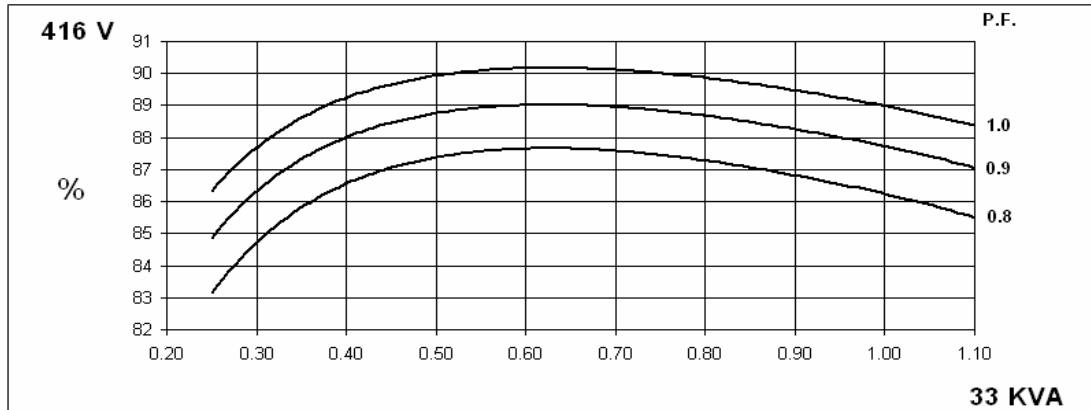

PI144G  
Winding 311  
AS480 AVR Without EBS  
Locked Rotor Motor Starting Curves

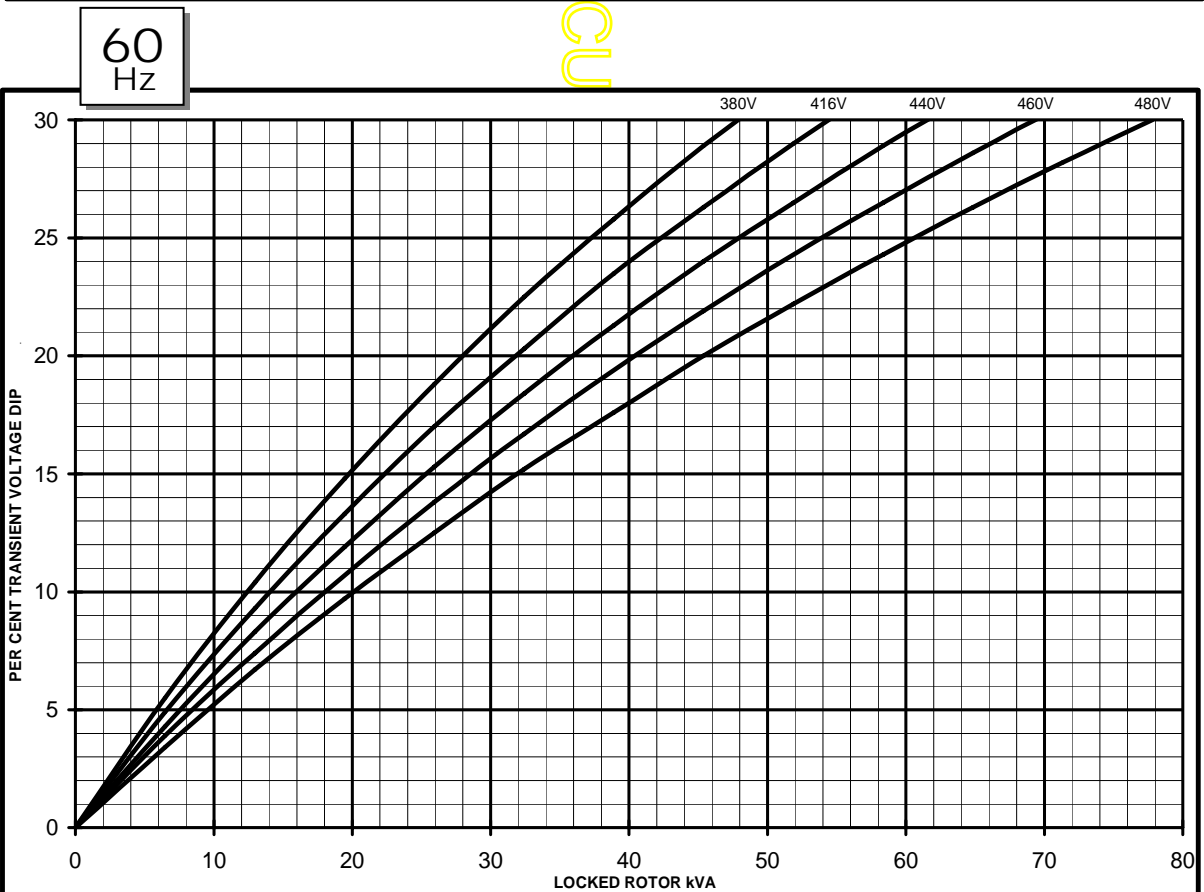
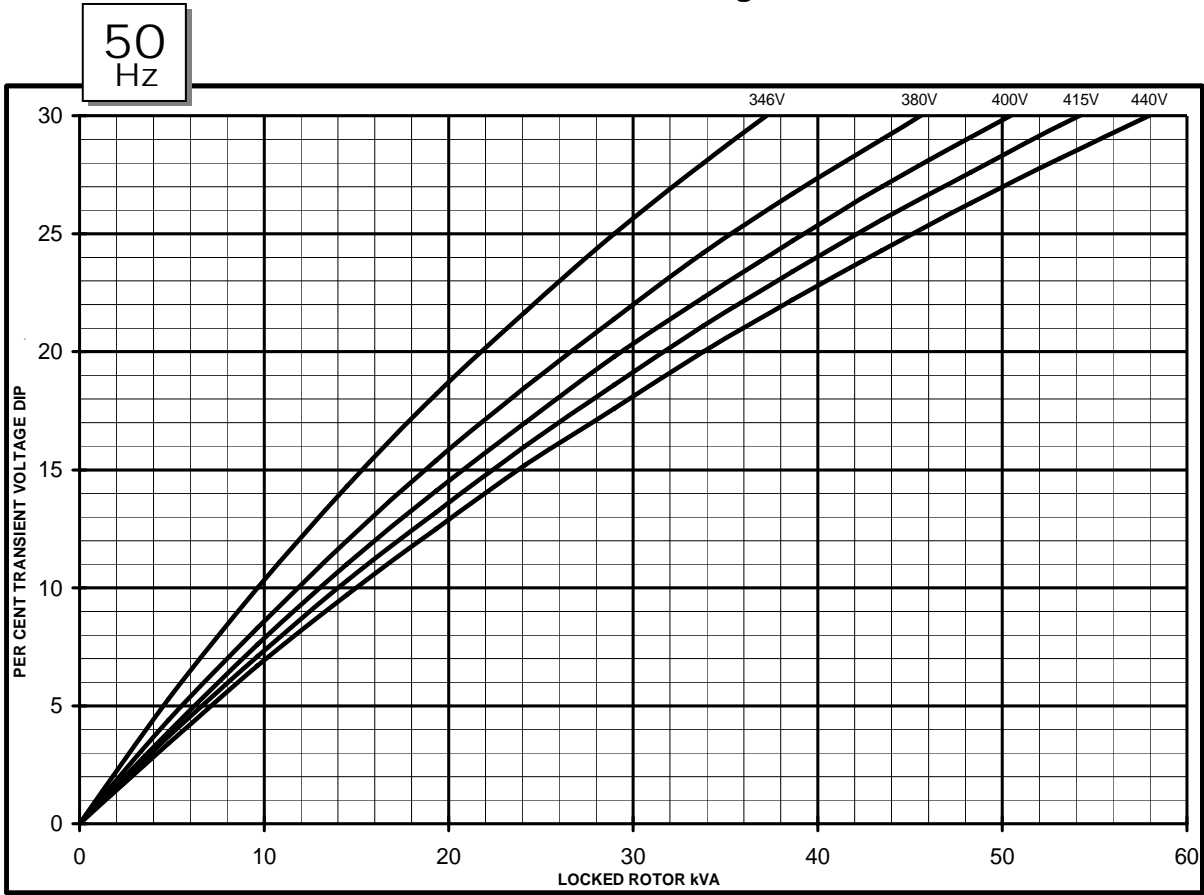

PI144G  
 Winding 311  
 AS480 AVR With EBS fitted  
 Locked Rotor Motor Starting Curves

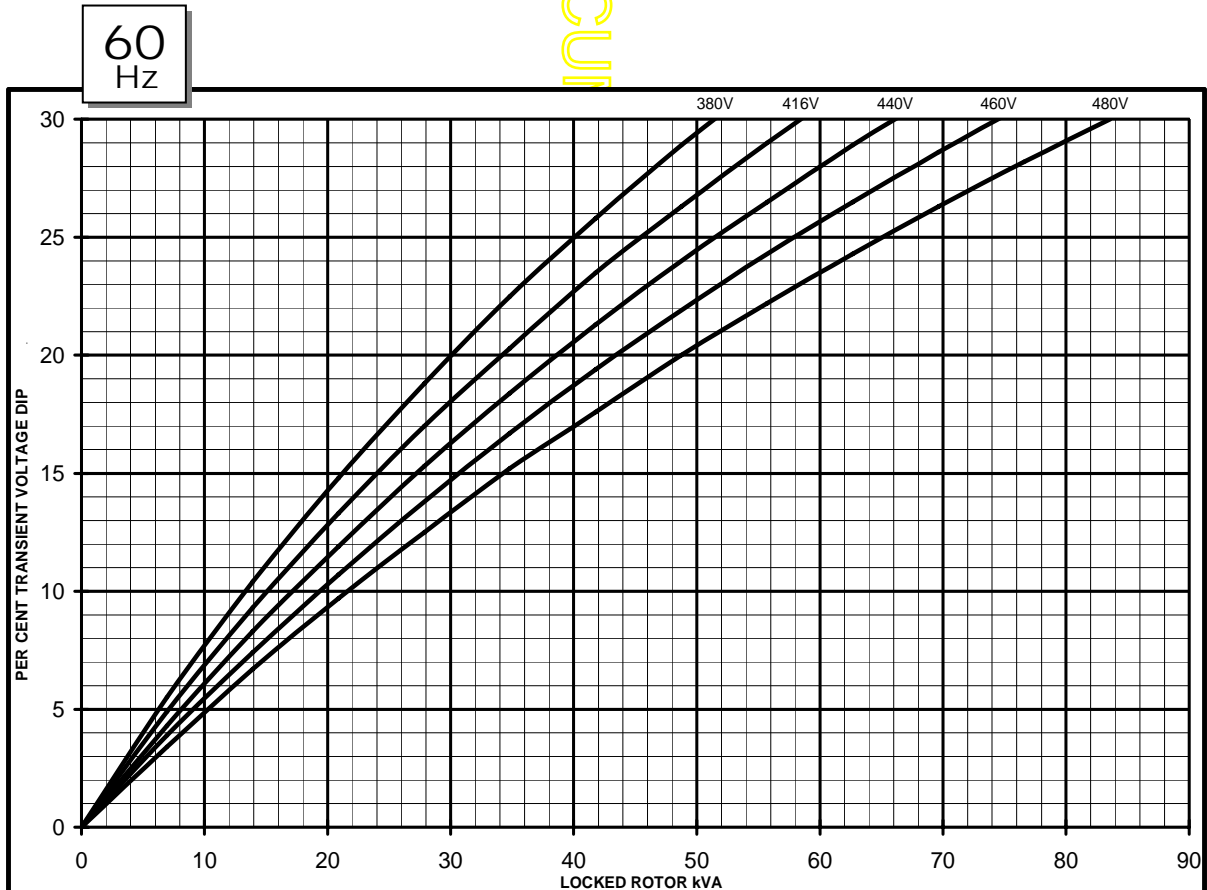
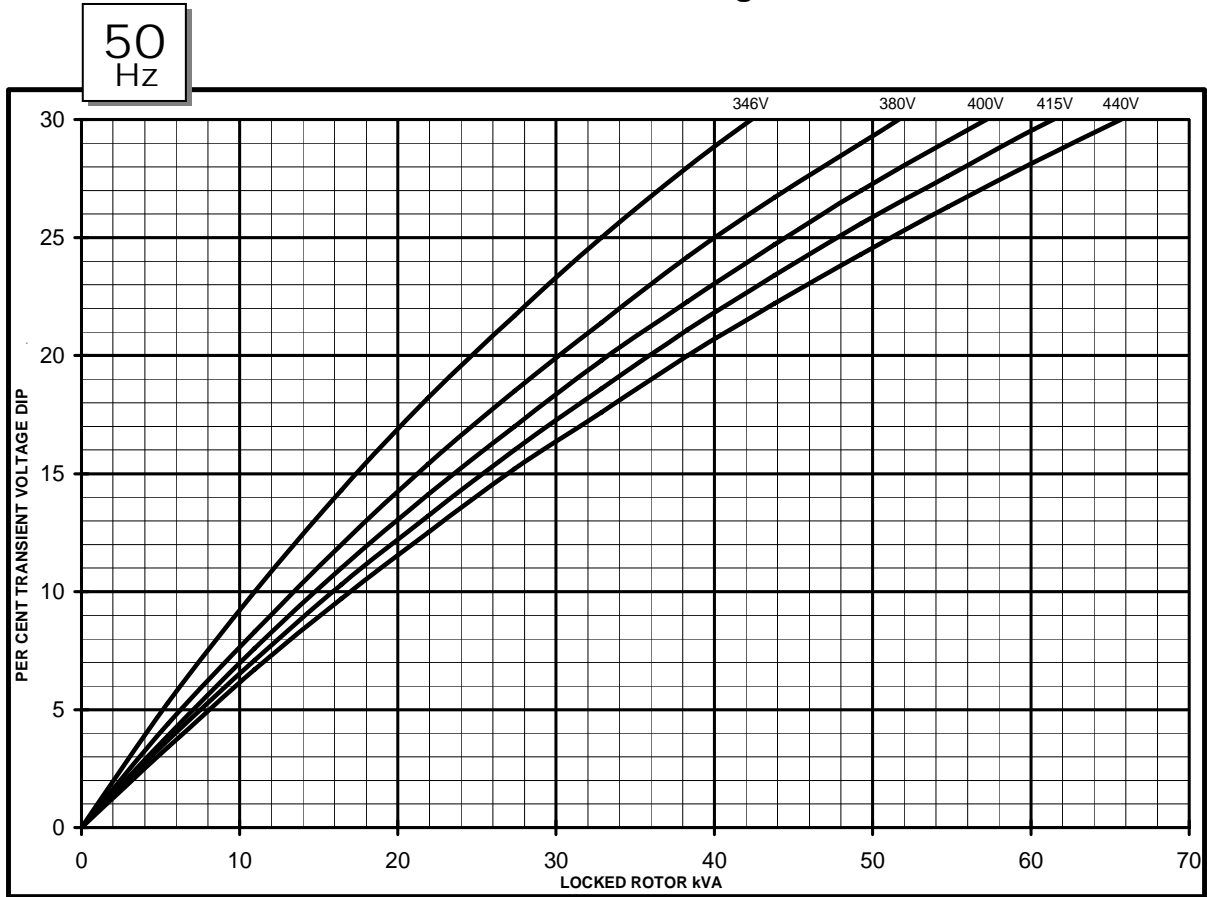

PI144G  
WITH EBS FITTED

**STAMFORD**

Three-phase Short Circuit Decrement Curve. No-load Excitation at Rated Speed  
Based on star (wye) connection.

50  
Hz

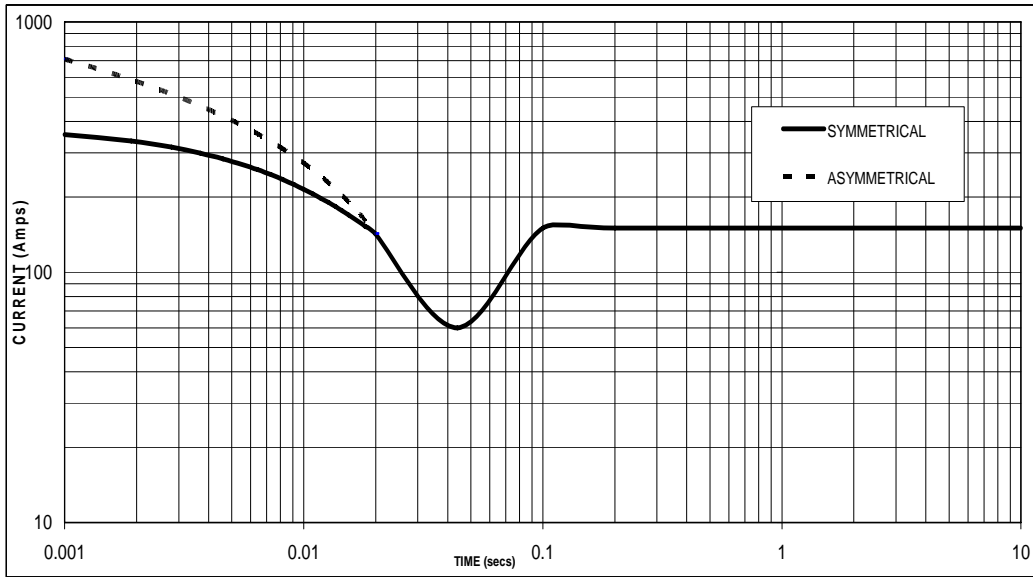

Sustained Short Circuit = 150 Amps

60  
Hz

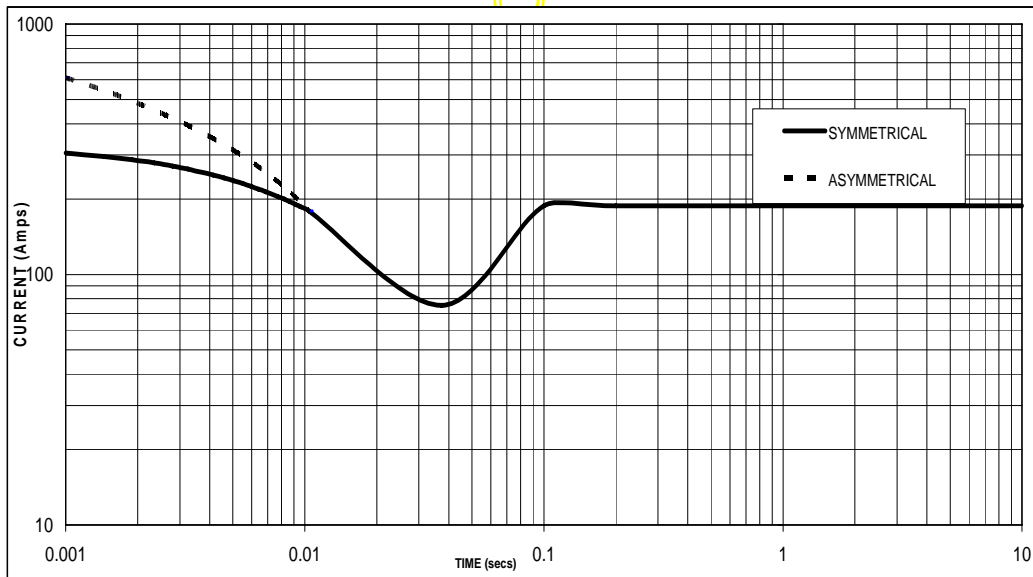

Sustained Short Circuit = 188 Amps

**Note 1**

The following multiplication factors should be used to adjust the values from curve between time 0.001 seconds and the minimum current point in respect of nominal operating voltage :

| 50Hz    |        | 60Hz    |        |
|---------|--------|---------|--------|
| Voltage | Factor | Voltage | Factor |
| 380v    | X 1.00 | 416v    | X 1.00 |
| 400v    | X 1.05 | 440v    | X 1.06 |
| 415v    | X 1.09 | 460v    | X 1.10 |
| 440v    | X 1.16 | 480v    | X 1.15 |

The sustained current value is constant irrespective of voltage level

**Note 2**

The following multiplication factor should be used to convert the values calculated in accordance with NOTE 1 to those applicable to the various types of short circuit :

|                         | 3-phase | 2-phase L-L | 1-phase L-N |
|-------------------------|---------|-------------|-------------|
| Instantaneous           | x 1.00  | x 0.87      | x 1.30      |
| Minimum                 | x 1.00  | x 1.80      | x 3.20      |
| Sustained               | x 1.00  | x 1.50      | x 2.50      |
| Max. sustained duration | 10 sec. | 5 sec.      | 2 sec.      |

All other times are unchanged

**Note 3**

Curves are drawn for Star (Wye) connected machines. For other connection the following multipliers should be applied to current values as shown :

Parallel Star = Curve current value X 2

Series Delta = Curve current value X 1.732



**PI144G**  
**Winding 311 / 0.8 Power Factor**

**RATINGS**

| Class - Temp Rise | Cont. F - 105/40°C |      |      |      | Cont. H - 125/40°C |      |      |      | Standby - 150/40°C |      |      |      | Standby - 163/27°C |      |      |      |     |
|-------------------|--------------------|------|------|------|--------------------|------|------|------|--------------------|------|------|------|--------------------|------|------|------|-----|
| <b>50 Hz</b>      | Series Star (V)    | 380  | 400  | 415  | 440                | 380  | 400  | 415  | 440                | 380  | 400  | 415  | 440                | 380  | 400  | 415  | 440 |
|                   | Parallel Star (V)  | 190  | 200  | 208  | 220                | 190  | 200  | 208  | 220                | 190  | 200  | 208  | 220                | 190  | 200  | 208  | 220 |
|                   | Series Delta (V)   | 220  | 230  | 240  | 254                | 220  | 230  | 240  | 254                | 220  | 230  | 240  | 254                | 220  | 230  | 240  | 254 |
| kVA               | 27.5               | 27.5 | 27.5 | 26.1 | 30.0               | 30.0 | 30.0 | 28.5 | 32.3               | 32.3 | 32.3 | 30.6 | 33.0               | 33.0 | 33.0 | 31.4 |     |
| kW                | 22.0               | 22.0 | 22.0 | 20.9 | 24.0               | 24.0 | 24.0 | 22.8 | 25.8               | 25.8 | 25.8 | 24.5 | 26.4               | 26.4 | 26.4 | 25.1 |     |
| Efficiency (%)    | 86.8               | 87.0 | 87.1 | 87.4 | 86.2               | 86.5 | 86.7 | 87.1 | 85.7               | 86.0 | 86.2 | 86.8 | 85.5               | 85.8 | 86.1 | 86.6 |     |
| kW Input          | 25.3               | 25.3 | 25.3 | 23.9 | 27.8               | 27.7 | 27.7 | 26.2 | 30.1               | 30.0 | 29.9 | 28.2 | 30.9               | 30.8 | 30.7 | 29.0 |     |

|                |                   |      |      |      |      |      |      |      |      |      |      |      |      |      |      |      |     |
|----------------|-------------------|------|------|------|------|------|------|------|------|------|------|------|------|------|------|------|-----|
| <b>60 Hz</b>   | Series Star (V)   | 416  | 440  | 460  | 480  | 416  | 440  | 460  | 480  | 416  | 440  | 460  | 480  | 416  | 440  | 460  | 480 |
|                | Parallel Star (V) | 208  | 220  | 230  | 240  | 208  | 220  | 230  | 240  | 208  | 220  | 230  | 240  | 208  | 220  | 230  | 240 |
|                | Delta (V)         | 240  | 254  | 266  | 277  | 240  | 254  | 266  | 277  | 240  | 254  | 266  | 277  | 240  | 254  | 266  | 277 |
| kVA            | 30.3              | 32.3 | 33.3 | 34.4 | 33.0 | 35.3 | 36.4 | 37.5 | 35.5 | 37.9 | 39.1 | 40.3 | 36.3 | 38.8 | 40.0 | 41.3 |     |
| kW             | 24.2              | 25.8 | 26.6 | 27.5 | 26.4 | 28.2 | 29.1 | 30.0 | 28.4 | 30.3 | 31.3 | 32.2 | 29.0 | 31.0 | 32.0 | 33.0 |     |
| Efficiency (%) | 87.1              | 87.1 | 87.2 | 87.2 | 86.7 | 86.6 | 86.7 | 86.8 | 86.2 | 86.2 | 86.3 | 86.3 | 86.0 | 86.0 | 86.1 | 86.2 |     |
| kW Input       | 27.8              | 29.6 | 30.5 | 31.5 | 30.4 | 32.6 | 33.6 | 34.6 | 32.9 | 35.2 | 36.3 | 37.3 | 33.7 | 36.0 | 37.2 | 38.3 |     |

**DIMENSIONS**

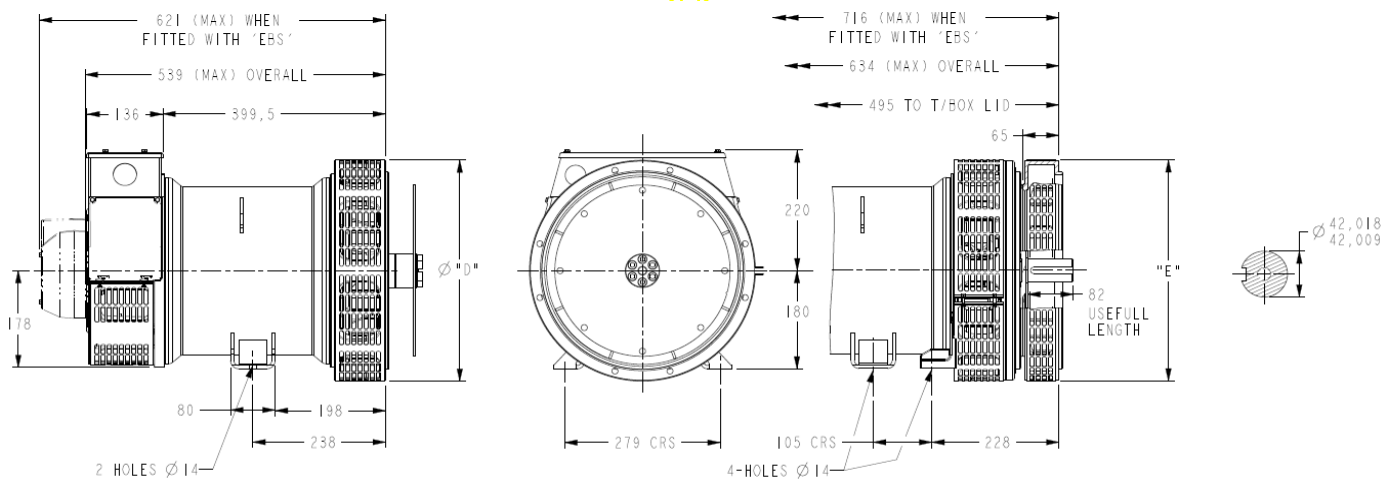

| COUPLING DISC |      |
|---------------|------|
| SAE           | "AN" |
| 6.5           | 30.2 |
| 7.5           | 30.2 |
| 8             | 62   |
| 10            | 53.8 |
| 11.5          | 39.6 |

| 1-BRG ADAPTOR |     |
|---------------|-----|
| SAE           | "D" |
| 5             | 361 |
| 4             | 405 |
| 3             | 451 |
| 2             | 489 |

8-HOLES SPACED AS 12  
 8-HOLES SPACED AS 12

| 2-BRG ADAPTOR |     |
|---------------|-----|
| SAE           | "E" |
| 5             | 359 |
| 4             | 406 |
| 3             | 455 |
| 2             | 493 |

APPROVED DOCUMENT

**STAMFORD**

Head Office Address:  
Barnack Road, Stamford  
Lincolnshire, PE9 2NB  
United Kingdom  
Tel: +44 (0) 1780 484000  
Fax: +44 (0) 1780 484100

[www.cumminsgeneratortechnologies.com](http://www.cumminsgeneratortechnologies.com)

Copyright 2010, Cummins Generator Technologies Ltd, All Rights Reserved  
Stamford and AvK are registered trade marks of Cummins Generator Technologies Ltd  
Cummins and the Cummins logo are registered trade marks of Cummins Inc.